

HOW TO ORDER

RHP-10X-100 F Y R

Packaging (50 pieces)
T = tube or R= tray (flanged type only)
B = bulk

TCR (ppm/°C)
Y = ±50 Z = ±100 N = ±250

Tolerance
J = ±5% F = ±1%

Resistance
R02 = 0.02 Ω 100 = 10.0 Ω
R10 = 0.10 Ω 101 = 100 Ω
1R0 = 1.00 Ω 512 = 51.0K Ω

Size/Type (refer to spec)
10X 20B 50A 100A
10B 20C 50B
10C 20D 50C

Series
High Power Resistor

FEATURES

- 100W, and 140W available
- TO126, TO220, TO263, TO247 packaging
- Surface Mount and Through Hole technology
- Resistance Tolerance from ±5% to ±1%
- TCR (ppm/°C) from ±250ppm to ±50ppm
- Complete thermal flow design
- Non-Inductive impedance characteristic and heat venting through the insulated metal tab
- Durable design with complete thermal conduction, heat dissipation, and vibration

APPLICATIONS

- RF circuit termination resistors
- CRT color video amplifiers
- Suits high-density compact installations
- High precision CRT and high speed pulse handling circuit
- High speed SW power supply
- Power unit of machines
- Motor control
- Drive circuits
- Automotive
- Measurements
- AC motor control
- RF linear amplifiers
- VHF amplifiers
- Industrial computers
- IPM, SW power supply
- Volt power sources
- Constant current sources
- Industrial RF power
- Precision voltage sources

Custom Solutions are Available – For more information, send your specification to sales@aacix.com.

CONSTRUCTION – shape X and A

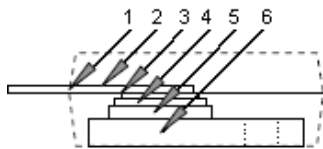

there is insulation between the flange and the resistor

1	Molding	Epoxy
2	Leads	Tin plated Cu
3	Conductor	Copper
4	Resistor	Ni-Cr
5	Substrate	Alumina
6	Flange	Ni plated Cu



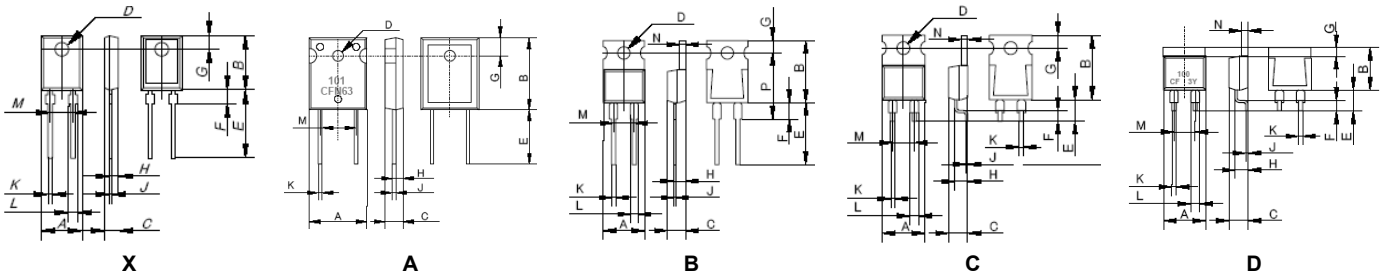





SCHEMATIC

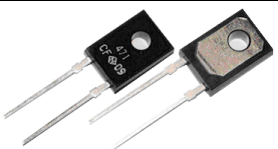

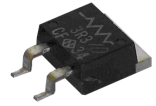
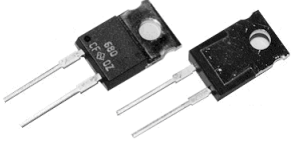
DIMENSIONS (mm)

Model	RHP-10X	RHP-10B	RHP-10C	RHP-20B	RHP-20C	RHP-20D	RHP-50A	RHP-50B	RHP-50C	RHP-100E
Shape	X	B	C	B	C	D	A	B	C	A
A	8.5 ± 0.2	8.5 ± 0.2	10.1 ± 0.2	10.1 ± 0.2	10.1 ± 0.2	10.1 ± 0.2	16.0 ± 0.2	10.6 ± 0.2	10.6 ± 0.2	16.0 ± 0.2
B	12.0 ± 0.2	12.0 ± 0.2	15.0 ± 0.2	15.0 ± 0.2	15.0 ± 0.2	10.3 ± 0.2	20.0 ± 0.5	15.0 ± 0.2	15.0 ± 0.2	20.0 ± 0.5
C	3.1 ± 0.2	3.1 ± 0.2	4.5 ± 0.2	4.5 ± 0.2	4.5 ± 0.2	4.5 ± 0.2	4.8 ± 0.2	4.5 ± 0.2	4.5 ± 0.2	4.8 ± 0.2
D	3.1 ± 0.1	3.1 ± 0.1	3.6 ± 0.1	3.6 ± 0.1	3.6 ± 0.1	-	3.2 ± 0.1	1.5 ± 0.1	1.5 ± 0.1	3.2 ± 0.1
E	17.0 ± 0.1	17.0 ± 0.1	5.0 ± 0.1	15.5 ± 0.1	5.0 ± 0.1	5.0 ± 0.1	14.5 ± 0.1	2.7 ± 0.1	2.7 ± 0.1	14.5 ± 0.5
F	3.2 ± 0.5	3.2 ± 0.5	2.5 ± 0.5	4.0 ± 0.5	2.5 ± 0.5	2.5 ± 0.5	-	5.08 ± 0.5	5.08 ± 0.5	-
G	3.8 ± 0.2	3.8 ± 0.2	3.0 ± 0.2	3.0 ± 0.2	3.0 ± 0.2	2.2 ± 0.2	5.1 ± 0.5	0.75 ± 0.2	0.75 ± 0.2	5.1 ± 0.5
H	1.75 ± 0.1	1.75 ± 0.1	2.75 ± 0.1	2.75 ± 0.2	2.75 ± 0.2	2.75 ± 0.2	3.63 ± 0.2	0.5 ± 0.2	0.5 ± 0.2	3.63 ± 0.2
J	0.5 ± 0.05	0.5 ± 0.05	0.5 ± 0.05	0.5 ± 0.05	0.5 ± 0.05	0.5 ± 0.05	-	1.5 ± 0.05	1.5 ± 0.05	-
K	0.6 ± 0.05	0.6 ± 0.05	0.75 ± 0.05	0.75 ± 0.05	0.75 ± 0.05	0.75 ± 0.05	0.8 ± 0.05	19 ± 0.05	19 ± 0.05	0.8 ± 0.05
L	1.4 ± 0.05	1.4 ± 0.05	1.5 ± 0.05	1.5 ± 0.05	1.5 ± 0.05	1.5 ± 0.05	-	2.7 ± 0.05	2.7 ± 0.05	-
M	5.08 ± 0.1	5.08 ± 0.1	5.08 ± 0.1	5.08 ± 0.1	5.08 ± 0.1	5.08 ± 0.1	10.9 ± 0.1	3.6 ± 0.1	3.6 ± 0.1	10.9 ± 0.1
N	-	-	1.5 ± 0.05	1.5 ± 0.05	1.5 ± 0.05	1.5 ± 0.05	-	15 ± 0.05	2.0 ± 0.05	-
P	-	-	-	16.0 ± 0.5	-	-	-	-	-	-

OVERVIEW

Model	Physical (top & bottom view)	Features
RHP-10X		<ul style="list-style-type: none"> TO126 Package 20W high power resistor 5.9 C/W heat resistance from hot spot to flange. 0.10 ohm to 220 ohm resistance range
RPH-10B		<ul style="list-style-type: none"> TO220 Package Through hole RHP-10B 20W high power 5.9 C/W heat resistance from hot spot to flange via thin film metallization technology 0.10 ohm to 220 ohm resistance range
RHP-10C		<ul style="list-style-type: none"> TO220 Package Surface mount RHP-10C 10W high power 5.9 C/W heat resistance from hot spot to flange via thin film metallization technology 0.10 ohm to 220 ohm resistance range
RHP-20B		<ul style="list-style-type: none"> TO220 Package Through hole RHP-20B 35W high power 3.3 C/W heat resistance from hot spot to flange via thin film metallization technology 0.02 ohm to 220 ohm resistance range
RHP-20C		<ul style="list-style-type: none"> TO220 Package Surface mount RHP-20C 20W 3.3 C/W heat resistance from hot spot to flange via thin film metallization technology 0.02 ohm to 220 ohm resistance range
RHP-20D		<ul style="list-style-type: none"> TO263 (D2P) Package - Surface Mount Molded 20W high power resistor 3.3 C/W heat resistance from hot spot to flange via thin film metallization technology 0.01 ohm to 51K ohm resistance range
RHP-50A		<ul style="list-style-type: none"> TO247 Package 100W high power resistor 1.3 C/W heat resistance from hot spot to flange via thin film metallization technology 0.01 ohm to 220 ohm resistance range
RHP-50B		<ul style="list-style-type: none"> TO220 Package Through hole RHP-50B 50W high power 2.3 C/W heat resistance from hot spot to flange via thin film metallization technology 0.10 ohm to 220 ohm resistance range
RHP-50C		<ul style="list-style-type: none"> TO220 Package Surface mount RHP-50C 50W high power 2.3 C/W heat resistance from hot spot to flange via thin film metallization technology 0.10 ohm to 220 ohm resistance range
RHP-100A		<ul style="list-style-type: none"> TO247 Package 140W high power resistor 0.9 C/W heat resistance from hot spot to flange or metal back plate. via thin film metallization technology 0.02 ohm to 220 ohm resistance range

ELECTRICAL SPECIFICATIONS

Model	RHP-10X	RHP-10B	RHP-10C	RHP-20D	RHP-20B	RHP-20C
Rated Power(heat sink)	20W	20W	20W	20W	35W	20W
Rated Power	1W	1W	1W	2W	1W	1W
Heat Resistance	5.9 C/W	5.9 C/W	5.9 C/W	3.3 C/W	3.3 C/W	3.3 C/W
Withstanding Voltage	2000V AC	2000V DC	2000V DC	2000V DC	2200V DC (1500V AC)	2200V DC (1500V AC)
Max. Operating Voltage	-	500V or $\sqrt{P \cdot R}$	500V or $\sqrt{P \cdot R}$	500V or $\sqrt{P \cdot R}$	500V or $\sqrt{P \cdot R}$	500V or $\sqrt{P \cdot R}$
Resistance	0.01 ~ 0.091		0.10 ~ 9.1		10 ~ 220	
Nominal Resistance	E6		E24		E24	
TCR (ppm°C)	±250		±100		±50	
Tolerance	±5%		±5%, ±1%		±1%	
Operating Temp.	-55°C ~ +155°C					

Model	RHP-50A	RHP-50B & RHP-50C	RHP-100A
Rated Power(heat sink)	100W	50W	100W
Rated Power	3W	1W	3W
Max. Applied Power	100W	-	-
Heat Resistance	1.3 C/W	2.3 C/W	0.9 C/W
Withstanding Voltage	2500V AC	2000V DC	2500V AC
Max. Operating Voltage	700V or $\sqrt{P \cdot R}$ (applied)	500V or $\sqrt{P \cdot R}$	700V or $\sqrt{P \cdot R}$ (applied)

Resistance	0.01~0.091	0.1 ~ 9.1	10 ~ 220	0.1 ~ 9.1	10 ~ 220	0.02~0.091	0.1 ~ 10KΩ	10 ~ 220
Nominal Resistance	E6	E12	E24	E24	E24	E6	E12	E24
TCR (ppm°C)	> ±250	±100	±50	±100	±50	> ±250	±100	±50
Tolerance	±5%	±5%, ±1%	±1%	±5%, ±1%	±1%	±5%	±5%, ±1%	±1%
Operating Temp.	-55°C ~ +155°C							

Resistance Range from 240 ohm to 51K ohm is available as a semi-custom solution for all of the RHP series.
Values such as 2.0, 2.5, 4.0, and 5.0 are available upon special request.

PERFORMANCE

Item	Performance	Condition
Rated Power	All other models	As specified
	RHP-50A, 100A	As specified
Rated Power (without heat sink)	All other models	Free Air
	RHP-20D	Attached on a simple footprint
Withstanding Voltage	As specified	60 seconds
Load Life	± (1.0%+0.05Ω)	25°C, 90 min on, 30 min. off, 1000 hrs.
Humidity	All other models	40°C, 90-95% RH, DC 0.1W, 1000 hrs.
	RHP-10X	60°C, 90-95% RH, DC 0.1W, 1000 hrs.
Temperature Cycle	All other models; RHP-20B & 20C (0.10 ~ 220Ω)	± (0.25%+0.05Ω)
	RHP-20B & 20C (0.02 ~ 0.091Ω)	± (1.0%+0.05Ω)
Soldering Heat	All other models; RHP-20B & 20C (0.10 ~ 220Ω)	± (0.1%+0.05Ω)
	RHP-50A, 100A	± (0.25%+0.05Ω)
	RHP-20B & 20C (0.02 ~ 0.091Ω)	± (0.5%+0.05Ω)
Solderability	All other models	> 95% of the surface
	RHP-10X, RHP-50A, 100A	> 75% of round
Insulation Resistance	> 1,000 Meg Ω	Between terminals and metal back plate
Vibration	± (0.25%+0.05Ω)	

The performance data applies to all RHP models unless otherwise noted.

RHP-10X

Derating Curve

Rating Power(W), with 2.8K/W heat sink.

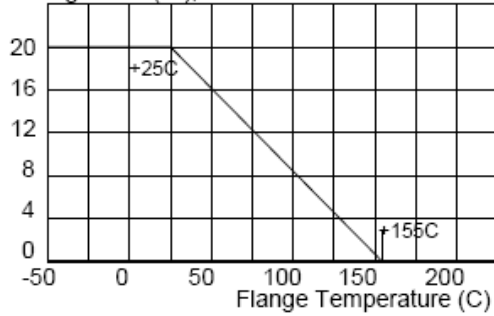

Temperature Rise at Flange Temperature(C)

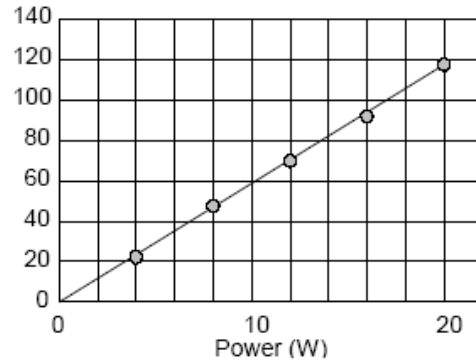

Frequency Characteristics

Impedance (ohm)

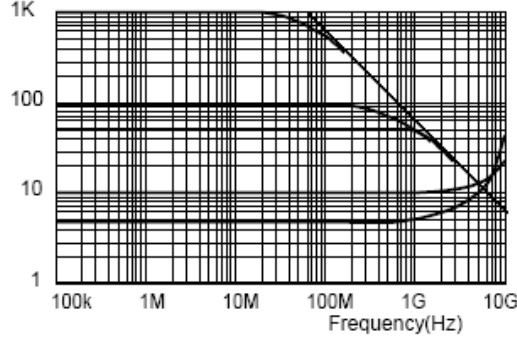

One time rectangular impulse Durability

Pulse Peak Watt (Watts)

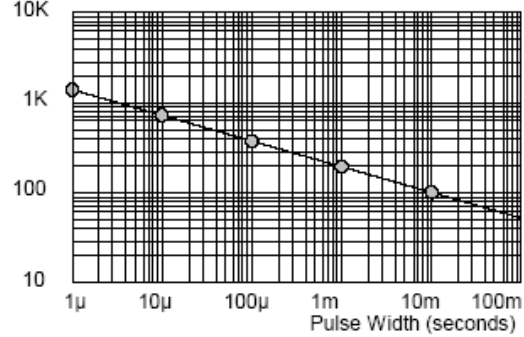

RHP-10B, RHP-10C

Power(W) Derating

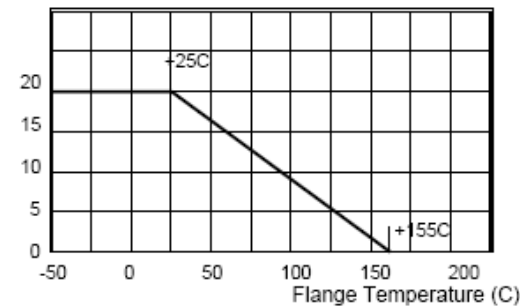

(C) Temperature Rise

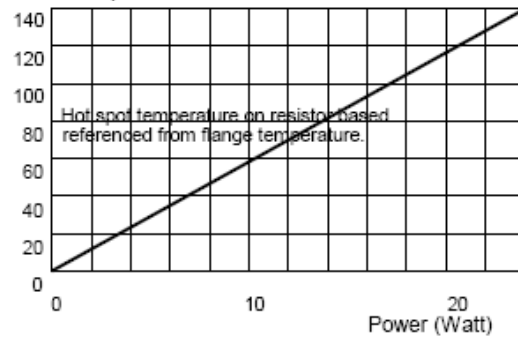

Pulse Energy Durability

Pulse Peak Watt (Watts), one time rectangular impulse.

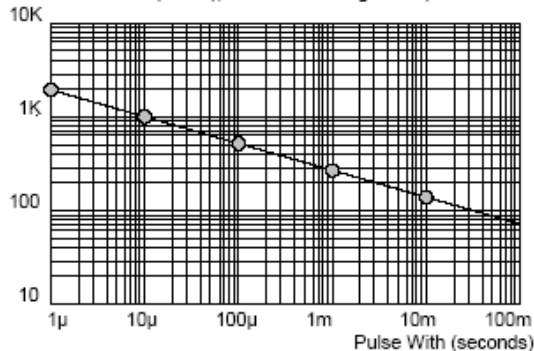

Frequency Characteristics

Impedance (ohm)

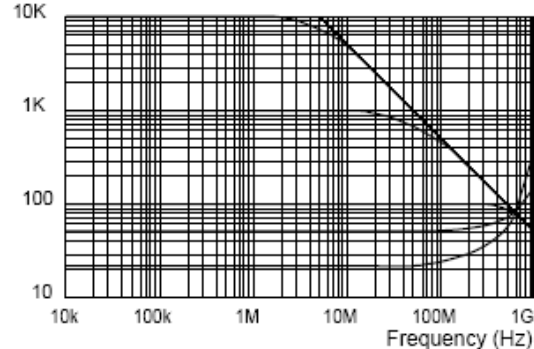

RHP-20B, RHP-20C

Derating

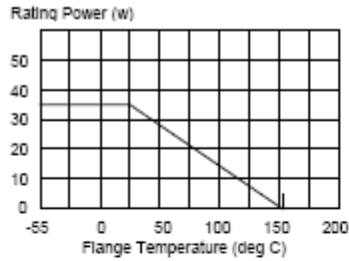

Temperature Rise

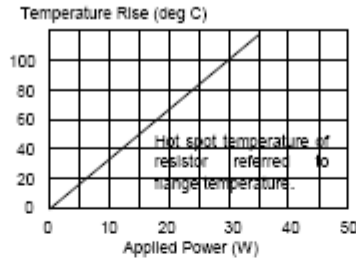

Typical TCR in Low Ohms

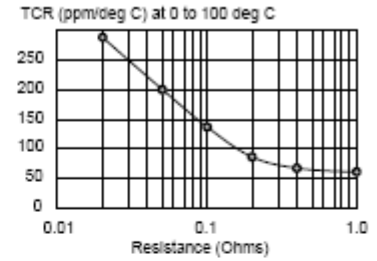

Pulse Energy Durability (Dot shows damage)

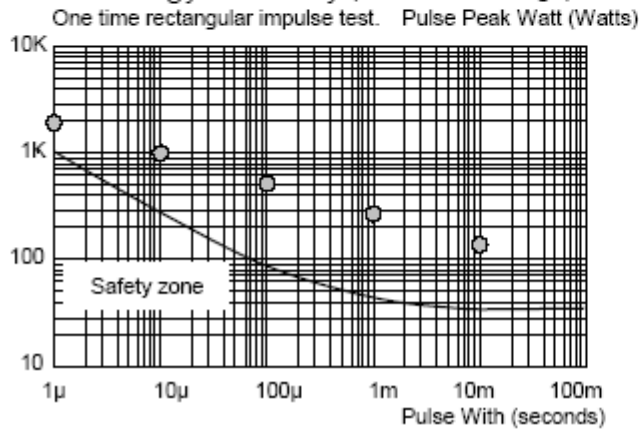

Frequency Characteristics

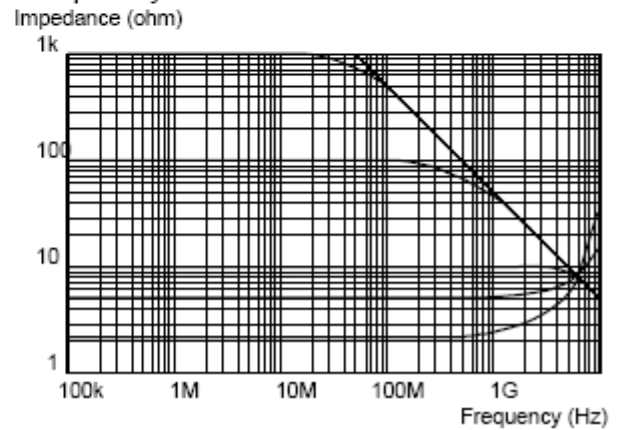

RHP-20D

Power Derating

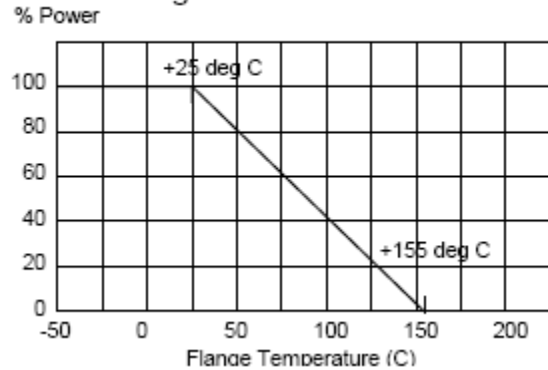

Temperature Rise

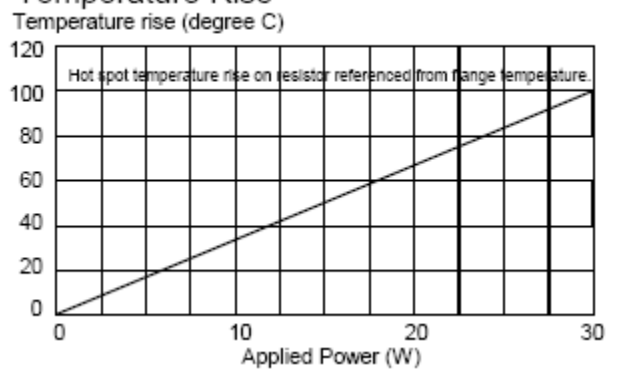

RHP-50A

Derating Curve
Rating Power(W)

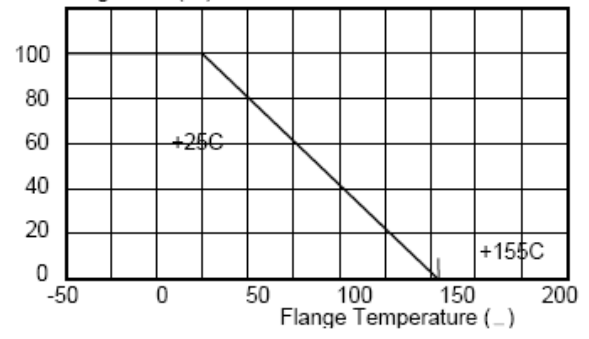

Temperature Rise
Temperature Rise (C)

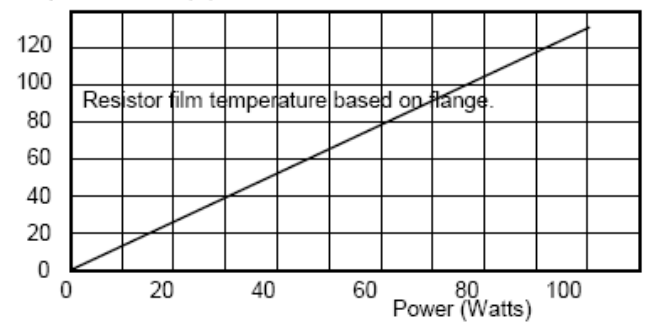

Pulse Energy Durability
Pulse Peak Watt (Watts)

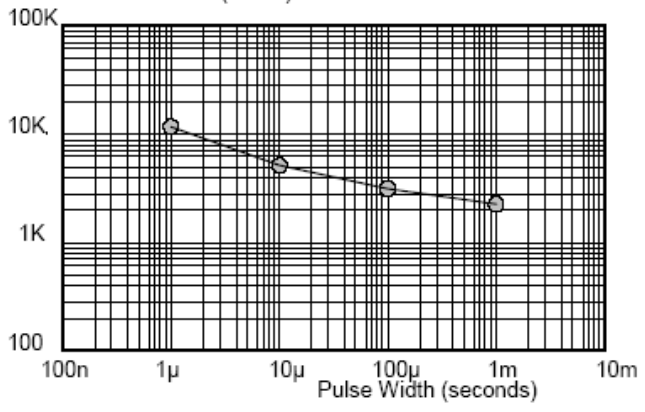

Frequency Characteristics
Impedance (ohm)

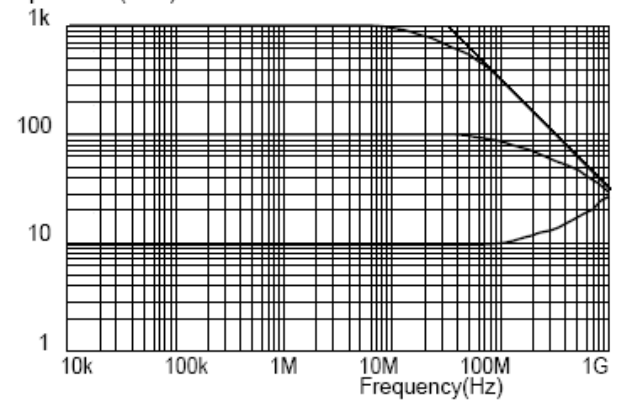

Humidity (Typical)

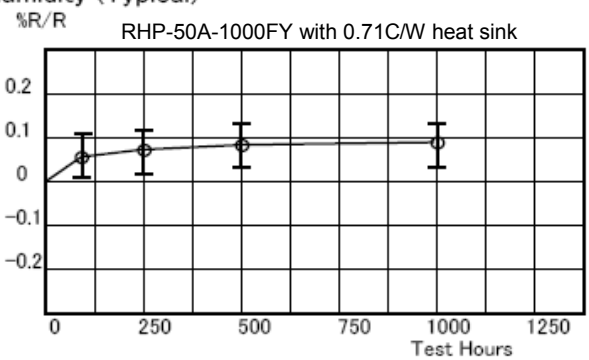

Load Life (Typical)

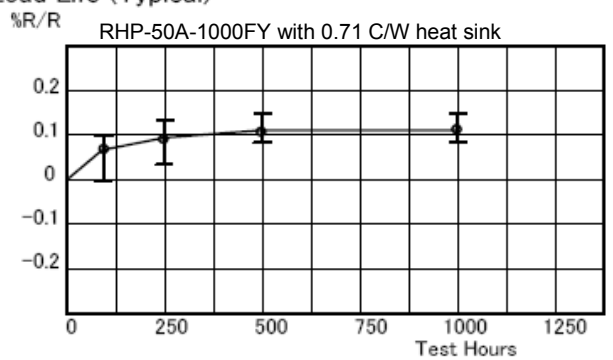

RHP-50B, RHP-50C

Derating

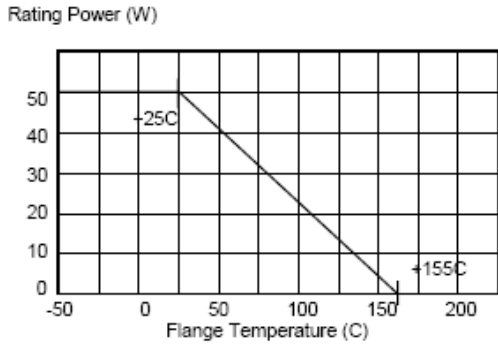

Temperature Rise

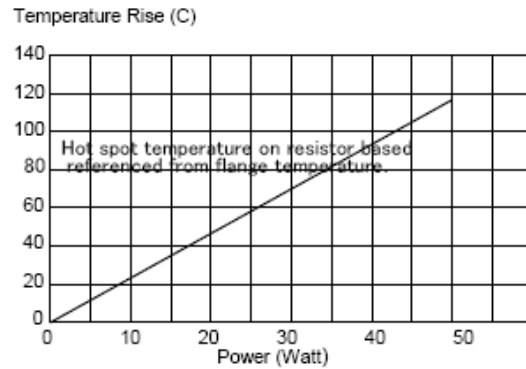

Pulse Energy Durability

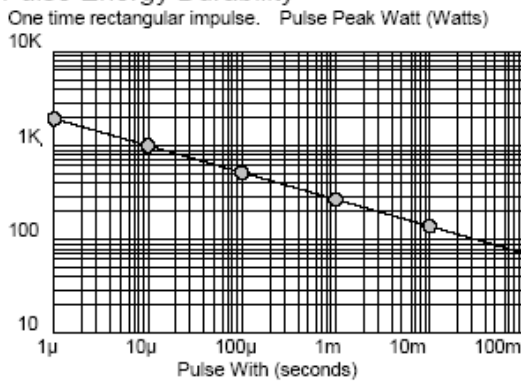

Frequency Characteristics

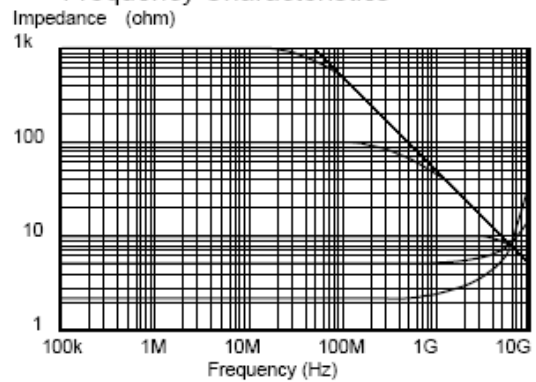

RHP-100A

Derating Curve

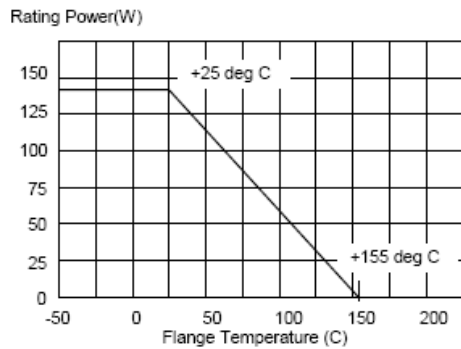

Temperature Rise

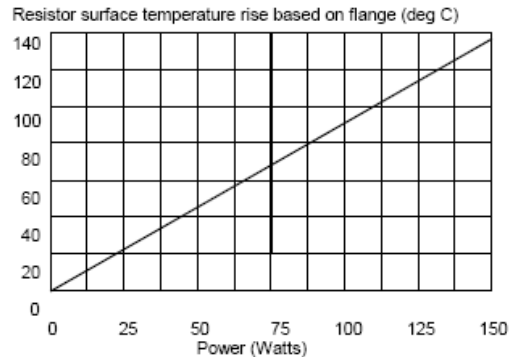

Pulse Energy Durability

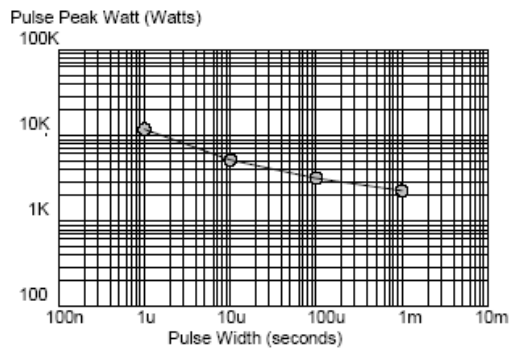

Frequency Characteristics

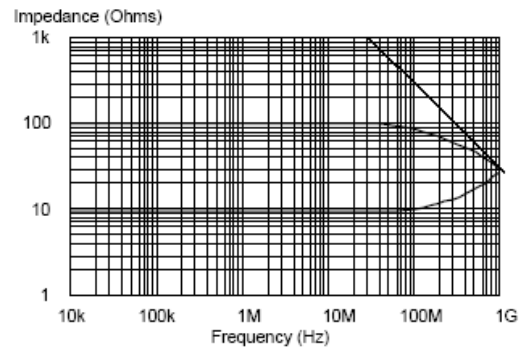

NOTES

GENERAL

- 0.1% tolerance resistors and resistance range from 240 ohm to 51K ohm are available as a semi-custom solution
- Use of heat conduction grease on surface of flange is recommended.
- Insulation material is unnecessary between flange and resistors; the flange and resistor are separated by alumina substrate.
- It surface mount soldering, temperature profile in the flange shall not exceed 220°C.
- Heat sink design will be performed when the resistor operating temperature is less than 155°C

RHP-10X

- Heat resistance between resistor and flange is 3.6K/W
- For application to r-f circuit, Lead formed RHP-10X (smd) is prepared; RHP-10X are screw mount style.
- At resistance from 220 to 51kohms rating power shall be restricted in 10W.

RHP-10B, RHP-10C

- Heat resistance between resistor and flange is 5.9 C/W.

RHP-20B, RHP-20C

- Heat resistance between resistor and flange is 3.3 C/W
- At resistance from 220 to 51kohms rating power shall be restricted in 20W.
- The terminal material is Tin plated copper, but inside of resistor contains PbAg high melting solder that is exempted by RoHS directive 2002/95/EC.

RHP-20D

- At flange soldering, temperature profile in flange shall not exceed 270°C for 30 minutes.
- Heat resistance between resistor and flange is 3.3C/W.
- This model shall be fit to Copper of printed wiring board with lower temperature solder than 220°C. Sn-Cu soldering will be done by soldering iron with 300°C -350°C tip temperature for less than 30 minutes.

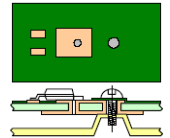

RHP-50A

- Using heat conduction grease on surface of flange is recommended.
- Heat resistance between resistor and flange is 1.3 K/W. Heat design will be done, as resistor temperature shall be under 155°C in operation.

RHP-50B, RHP-50-C

- Heat resistance between resistor and flange is 3.3 C/W.
- 5ppm TCR resistors are available as a semi-custom product
- At resistance from 220 to 51kohms rating power shall be restricted in 30W.
- Please note, terminal material is Tin plated copper, but inside of resistor contains PbAg high melting solder that is exempted by RoHS directive 2002/95/EC.

RHP-100A

Recommendation

- Flat surface heat sink, thermal compound and sufficient mount screw torque will be necessary for good heat transfer.
- In a rush current protection application, such as charge current limitation resistor, sufficient power derating will be necessary.

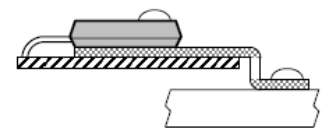

Design for Heat Release

TAPE DIMENSIONS (mm)

Reel Dimensions

Outer Diameter: 300mm
 Inner Diameter: 100mm
 Width: 23.9mm min., 27.4mm max

Standard packaging is RoHS PS/PE tube packaging, which contains 50 pieces per tube. When ordering, note Tube (T) or Tray (R)

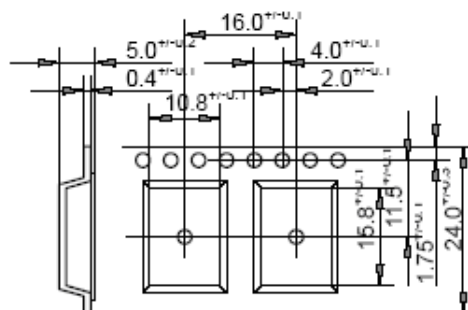

The content of this specification may change without notification 3/02/2011