

Custom solutions are available.

## HOW TO ORDER

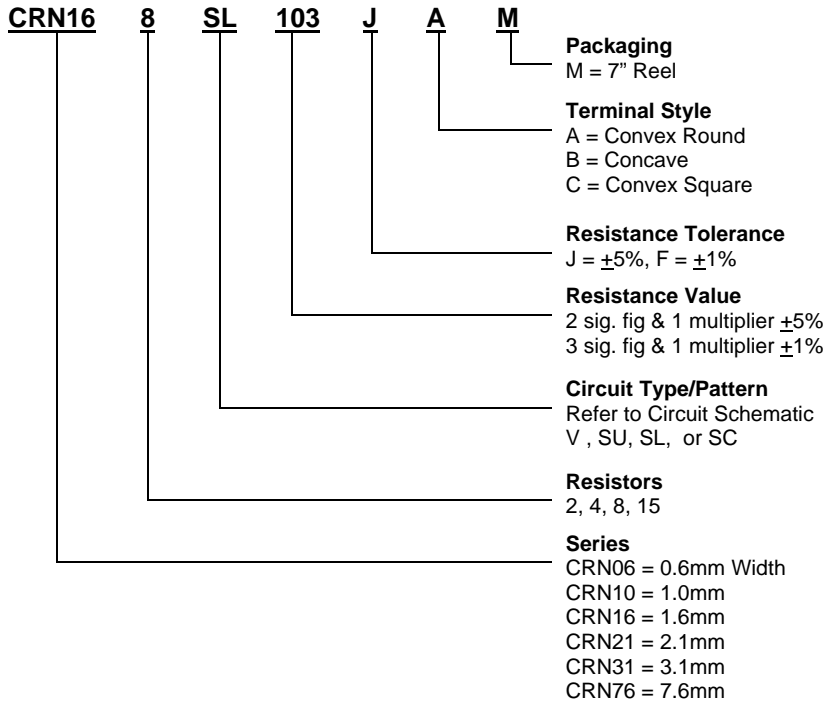

## FEATURES

- Single Component reduces board space and component count
- Resistance Tolerances of  $\pm 5\%$ ,  $\pm 2\%$ , and  $\pm 1\%$
- Convex and Concave Termination
- Isolated and Bussed Circuitry
- Flow Solderable
- ISO/TS 16949:2002 Certified
- Applicable Specifications: EIA575 and JISC5202
- Lead Free and RoHS Compliant

## CONSTRUCTION

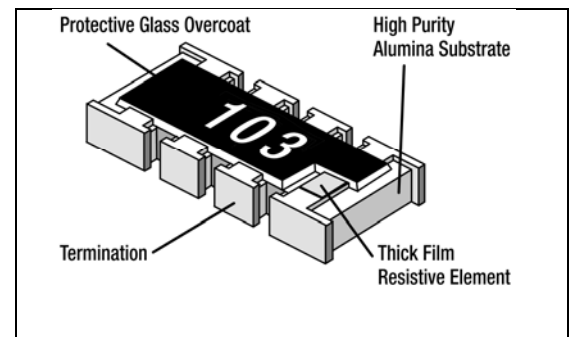

## ELECTRICAL SPECIFICATIONS SMALL/STANDARD SIZE

Series	Resistor/Pin		Circuit	Terminal	Resistance (ohm)	Tolerance	Power Rating*	Voltage		Operating Temperature
								Working	Overload	
CRN06-2V	2	4	Isolated	C	10- 1M	$\pm 5\%$	0.031W	25V	50V	-55°C ~ +125°C
CRN10-2V	2	4	Isolated	C	10- 1M	$\pm 5\%$	0.063W	25V	50V	-55°C ~ +125°C
CRN10-4V	4	8	Isolated	B, C	10- 1M	$\pm 1\%$ , $\pm 5\%$	0.063W	25V	50V	-55°C ~ +125°C
CRN16-2V	2	4	Isolated	B, C	0, 10- 1M	$\pm 5\%$	0.063W	50V	100V	-55°C ~ +125°C
CRN16-4V	4	8	Isolated	A, B, C	0, 10- 1M	$\pm 1\%$ , $\pm 2\%$ , $\pm 5\%$	0.063W	50V	100V	-55°C ~ +125°C
CRN16-8V	8	16	Isolated	C	0, 10- 1M	$\pm 1\%$ , $\pm 5\%$	0.031W	25V	50V	-55°C ~ +125°C
CRN16-8SU	8	10	Bussed	C	0, 10- 1M	$\pm 5\%$	0.031W	25V	50V	-55°C ~ +125°C
CRN21-8SC	8	10	Bussed	B	0, 10- 1M	$\pm 5\%$	0.063W	25V	50V	-55°C ~ +125°C

\* Power rating is @ 70°C

## ELECTRICAL SPECIFICATIONS STANDARD/LARGE SIZE

CRN31-4V	4	8	Isolated	A, B, C	0, 10- 1M	$\pm 1\%$ , $\pm 2\%$ , $\pm 5\%$	0.125W	50V	100V	-55°C ~ +125°C
CRN31-8SL	8	10	Bussed	B, C	0, 10- 1M	$\pm 1\%$ , $\pm 2\%$ , $\pm 5\%$	0.063W	50V	100V	-55°C ~ +125°C
CRN31-8SU	8	10	Bussed	B, C	0, 10- 1M	$\pm 1\%$ , $\pm 2\%$ , $\pm 5\%$	0.063W	50V	100V	-55°C ~ +125°C
CRN31-8V	8	16	Isolated	A	0, 10- 1M	$\pm 5\%$	0.063W	50V	100V	-55°C ~ +125°C
CRN31-15SU	15	16	Bussed	A	0, 10- 1M	$\pm 5\%$	0.063W	50V	100V	-55°C ~ +125°C
CRN76-8V	8	16	Isolated	A	0, 10- 1M	$\pm 5\%$	0.125W	50V	100V	-55°C ~ +125°C
CRN76-15SU	15	16	Bussed	A	0, 10- 1M	$\pm 5\%$	0.063W	50V	100V	-55°C ~ +125°C

\* Power rating is @ 70°C

## NOTICE OF AMENDMENT

As of August 2001, the **AAC** part numbers have been changed.  
Please update your files accordingly.

A cross-reference is provided below for part numbers published prior to August 2001 to the current part number. If you need additional information, please contact customer service at 949-453-9888 or sales@aacix.com at any time.

### CROSS – REFERENCE CHIP ARRAY

Prior Series	New Series	Dimensions	Resistors/Pin		Circuit	Terminals	Tolerance
<b>New part</b>	CRN06-2V	0.80 x 0.60mm	2	4	Isolated	Convex-Square	±5%
CRN10-2	CRN10-2V	1.00 x 1.00mm	2	4	Isolated	Convex-Square	±5%
CRN10-4	CRN10-4V	2.00 x 1.00mm	4	8	Isolated	Convex-Square, Concave	±1%, ±5%
CRN16-2	CRN16-2V	1.60 x 1.60mm	2	4	Isolated	Convex-Square, Concave	±5%
CRN16-4	CRN16-4V	3.20 x 1.60mm	4	8	Isolated	Convex-Round, Convex-Square, Concave	±1%, ±2%, ±5%
<b>New part</b>	CRN16-8V	4.00 x 1.60mm	8	16	Isolated	Convex-Square	±1%, ±5%
CRN35-8	CRN16-8SU	3.20 x 1.60mm	8	10	Bussed	Convex-Square	±5%
CRN36-8	<b>Discontinued</b>	3.20 x 1.60mm	8	10	Bussed	Convex-Round, Convex-Square	±5%
CRN33-8	CRN21-8SC	4.00 x 2.10mm	8	10	Bussed	Concave	±5%
CRN30-4	CRN31-4V	5.08 x 3.10mm	4	8	Isolated	Convex-Round, Convex-Square, Concave	±1%, ±2%, ±5%
CRN31-8	CRN31-8SL	6.40 x 3.10mm	8	10	Bussed	Concave, Convex-Square	±1%, ±2%, ±5%
CRN34-8	CRN31-8SU	6.40 x 3.10mm	8	10	Bussed	Concave, Convex-Square	±1%, ±2%, ±5%
CRN32-7	<b>Discontinued</b>	5.08 x 3.10mm	7	8	Bussed	Convex-Round	±5%
CRN38-16	CRN31-8V	10.16 x 3.10mm	8	16	Isolated	Convex-Round	±5%
CRN37-9	<b>Discontinued</b>	6.40 x 3.10mm	9	10	Bussed	Convex-Round	±5%
CRN38-15	CRN31-15SU	10.16 x 3.10mm	15	16	Bussed	Convex-Round	±5%
<b>New part</b>	CRN76-8V	10.16 x 7.62mm	8	16	Isolated	Convex-Round	±5%
<b>New part</b>	CRN76-15SU	10.16 x 7.62mm	15	16	Bussed	Convex-Round	±5%

## Dimensions & Schematics

**CRN06-2V** Convex-Square

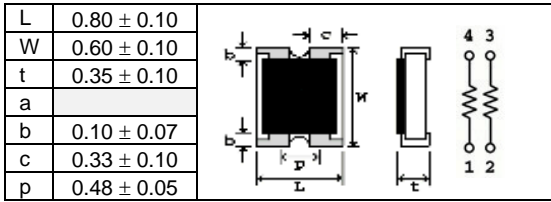

**CRN10-2V** Convex-Square

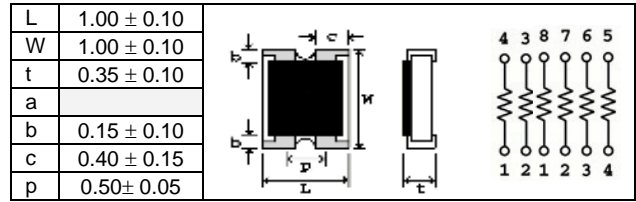

**CRN10-4V** Concave

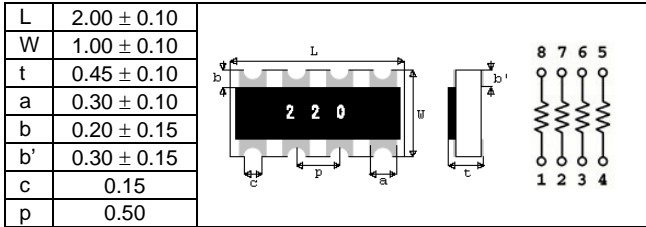

**CRN10-4V** Convex-Square

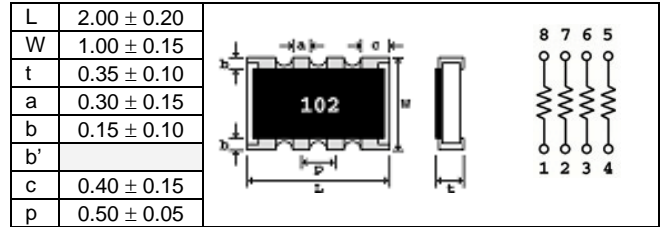

**CRN16-2V** Concave

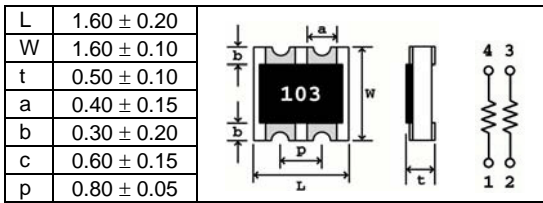

**CRN16-2V** Convex-Square

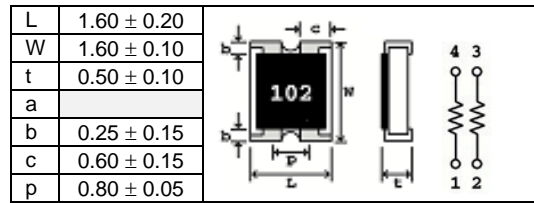

**CRN16-4V** Convex-Round

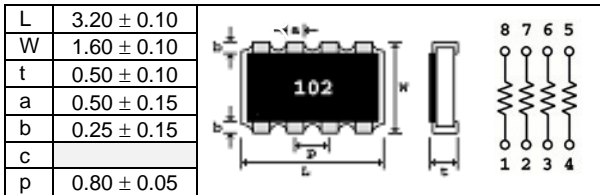

**CRN16-4V** Concave

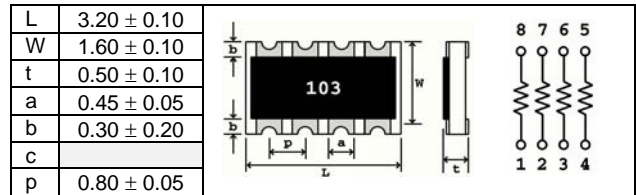

**CRN16-4V** Convex-Square

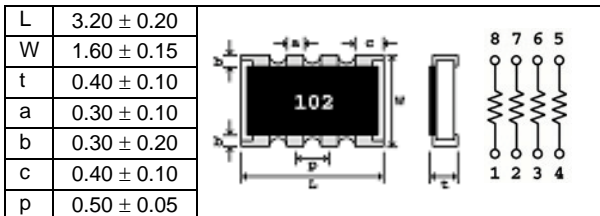

**CRN16-8SU** Convex-Square

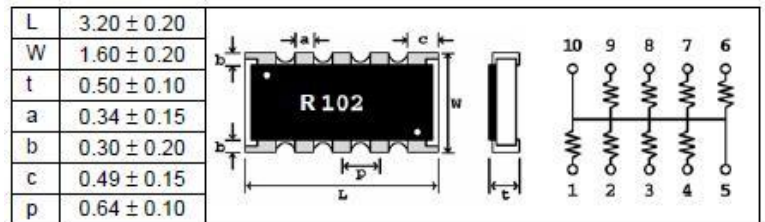

**CRN16-8V** Convex-Square

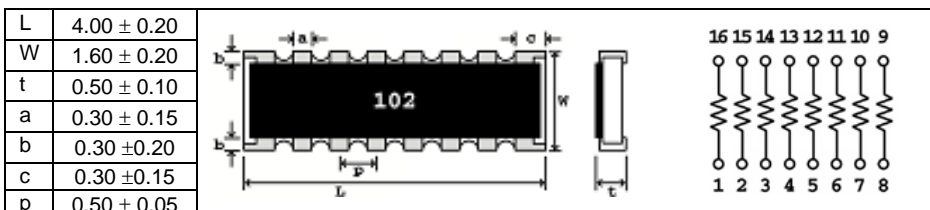

The content of this specification may change without notification

### CRN21-8SC Concave

L	4.00 ± 0.20
W	2.10 ± 0.20
t	0.60 ± 0.10
a	0.50 ± 0.20
b	0.25 ± 0.20
c	
p	0.80 ± 0.10

### CRN31-4V Convex-Round

L	5.08 ± 0.20
W	3.10 ± 0.20
t	0.55 ± 0.10
a	0.80 ± 0.20
b	0.50 ± 0.20
c	
p	1.27 ± 0.10

### CRN31-4V Concave

L	5.08 ± 0.20
W	3.00 ± 0.20
t	0.60 ± 0.10
a	0.80 ± 0.20
b	0.55 ± 0.20
b'	
p	1.27 ± 0.10

### CRN31-4V Convex-Square

L	5.08 ± 0.20
W	3.10 ± 0.20
t	0.55 ± 0.10
a	0.80 ± 0.20
b	0.50 ± 0.20
b'	0.30 ± 0.20
p	1.27

### CRN31-8SL/SU Concave

L	6.40 ± 0.20
W	3.10 ± 0.20
t	0.60 ± 0.10
a	0.70 ± 0.20
a²	
b	0.35 ± 0.15
b'	
p	1.27 ± 0.10

### CRN31-8SL/SU Convex-Square

L	6.40 ± 0.20
W	3.20 ± 0.20
t	0.60 ± 0.10
a	0.80 ± 0.20
a²	1.05
b	0.50 ± 0.20
b'	0.30 ± 0.20
p	1.27

SU Circuit

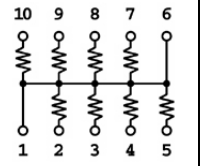

SL Circuit

### CRN31-8V Convex-Round

L	10.16 ± 0.20
W	3.10 ± 0.20
t	0.55 ± 0.10
a	0.80 ± 0.20
b	0.50 ± 0.20
p	1.27 ± 0.10

### CRN31-15SU Convex-Round

L	10.16 ± 0.20
W	3.10 ± 0.20
t	0.55 ± 0.10
a	0.80 ± 0.20
b	0.50 ± 0.20
p	1.27 ± 0.10

## CRN76-8V Convex-Round

L	10.16 ±0.20
W	7.62 ± 0.20
t	0.70 ± 0.20
a	0.80 ± 0.20
b	0.80 ± 0.20
c	
p	1.27 ± 0.10

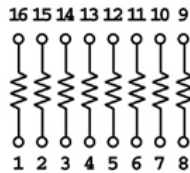
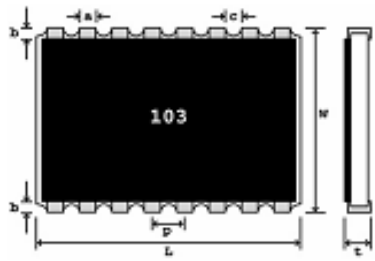

## CRN76-15SU Convex-Round

L	10.16 ±0.20
W	7.62 ± 0.20
t	0.70 ± 0.20
a	0.80 ± 0.20
b	0.80 ± 0.20
c	
p	1.27 ± 0.10

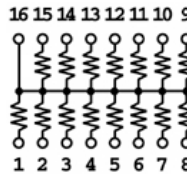
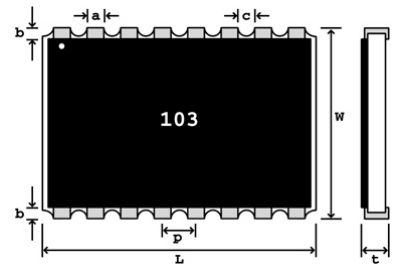

## ELECTRICAL CHARACTERISTICS

Test Item	Conditions of Test	Test Results
Life/Endurance Test	EIA 575, π 3.14 1000 hours at 70°C, 1.5 hours "on", 0.5 hours "off"	± 1.5%
Shot Time Overload	EIA 575, π 3.6 Short time overload	± 0.5%
Thermal Shock	EIA 575, π 3.5	± 0.5%
Moisture Resistance	EIA 575, π 3.10	± 1.0%
Resistance to Soldering Heat	EIA 575, π 3.8 10 seconds at 260°C solder bath temperature	± 2.0%
High Temperature Exposure	EIA 575, π 3.7	± 1.0%
Low Temperature Operations	EIA 575, π 3.6	± 0.5%
Solderability & Leaching	EIA 575, π 3.12	95% Coverage

## DERATING CURVE

The resistor shall have a power rating based on continuous full-load operation at an ambient temperature of 70°C, the load shall be derated in accordance with the figure below.

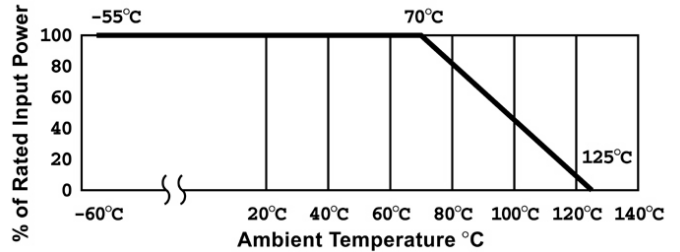

## REEL DRAWINGS & DIMENSIONS (mm)

7" Reel (M)	
M	180±0.3
H	1.20
C	13.0 ± 0.2
G	9.0 ± 0.3
E	56 ± 1.0
F	11.4 ± 1.0

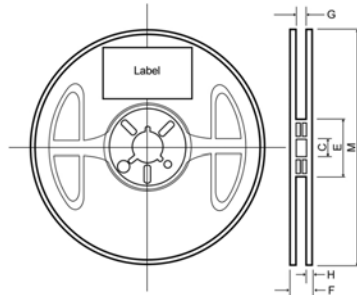

13" Reel (V)	
M	330±2.5
H	2.3± 0.5
C	13.0 ± 0.2
G	9.5 ± 0.5
E	80.0 ± 1.0
F	14.4

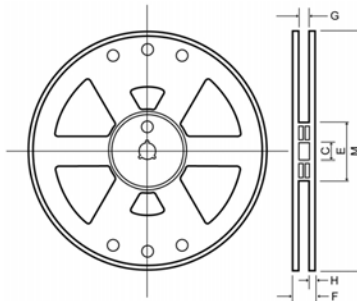

## PACKAGING SPECIFICATION

Size	Tape	7" Reel Quantity
CRN06-2V	Paper Tape	10,000
CRN10-2V	Paper Tape	10,000
CRN10-4V	Paper Tape	10,000
CRN16-2V	Paper Tape	5,000
CRN16-4V	Paper Tape	5,000
CRN16-8V	Paper Tape	4,000
CRN16-8SU	Paper Tape	5,000
CRN21-8SC	Plastic Tape	4,000
CRN31-4V	Plastic Tape	4,000
CRN31-8SL	Plastic Tape	4,000
CRN31-8SU	Plastic Tape	4,000
CRN31-8V	Plastic Tape	2,000
CRN31-15SU	Plastic Tape	2,000
CRN76-8V	Plastic Tape	1,000
CRN76-15SU	Plastic Tape	1,000

## LABEL DESCRIPTION

An identification label is on one side surface of a reel, marked with the following items of information.

1. Chip Resistor Array or Network
2. Part Number
3. Quantity
4. Lot Number \*
5. Manufacturer's name

\* The suffix "L" on the lot number indicates that this item is lead free. As of September 2004, all new production items of the series CRN are no longer containing tin/lead (SnPb) terminals; they are lead free and in compliance with Lead Free/RoHS.

The content of this specification may change without notification