

Tin / Tin Lead / Silver Palladium / Gold Terminations Available

HOW TO ORDER

Custom solutions are available.

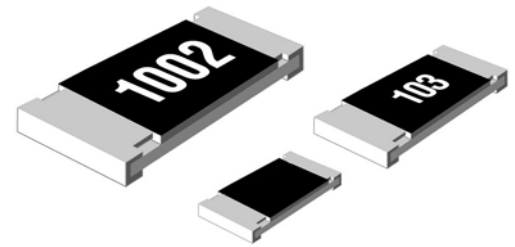
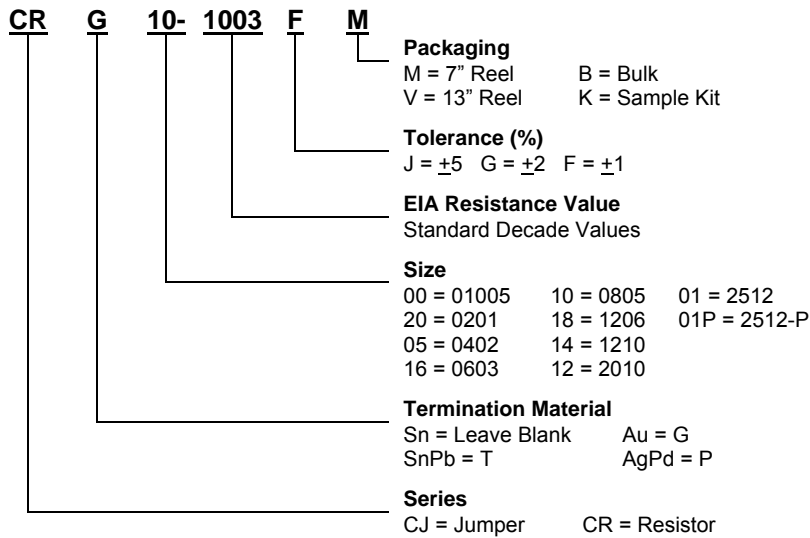

FEATURES

- Excellent stability over a wide range of environmental conditions
- CR and CJ types in compliance with RoHS
- CRP and CJP types constructed with AgPd Terminals, Epoxy Bondable
- CRG and CJG types constructed top side terminations, wire bond pads, with Au termination material.
- Operating temperature -55°C ~ +125°C
- Appl. Specifications: EIA 575, IEC 60115-1, JIS 5201-1, and MIL-R-55342G
- ISO/TS 16949:2002 Certified

SCHEMATIC

Wrap Around Terminal
CR, CJ, CRP, CJP type

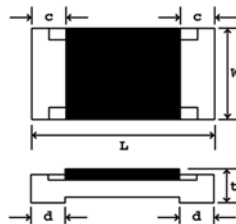

Top Side Termination, Bottom Isolated
CRG, CJG type

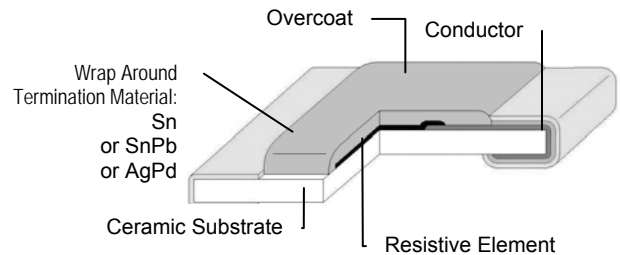
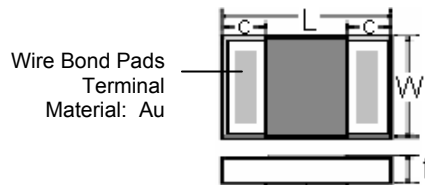

DIMENSIONS (mm)

Size	Size Code	L	W	c	d	t
01005	00	0.40 ± 0.02	0.20 ± 0.02	0.08 ± 0.03	0.10 ± 0.03	0.12 ± 0.02
0201	20	0.60 ± 0.03	0.30 ± 0.03	0.10 ± 0.05	0.15 ± 0.05	0.25 ± 0.05
0402	05	1.00 ± 0.05	0.5+0.1-0.05	0.20 ± 0.10	0.25+0.05-0.10	0.35 ± 0.05
0603	16	1.60 ± 0.10	0.80 ± 0.10	0.20 ± 0.10	0.30+0.20-0.10	0.50 ± 0.10
0805	10	2.00 ± 0.15	1.25 ± 0.15	0.40 ± 0.25	0.30+0.20-0.10	0.50 ± 0.15
1206	18	3.20 ± 0.15	1.60 ± 0.15	0.45 ± 0.25	0.40+0.20-0.10	0.60 ± 0.15
1210	14	3.20 ± 0.20	2.60 ± 0.20	0.50 ± 0.30	0.40+0.20-0.10	0.60 ± 0.10
2010	12	5.00 ± 0.20	2.50 ± 0.20	0.50 ± 0.30	0.50+0.20-0.10	0.60 ± 0.10
2512	01	6.30 ± 0.20	3.10 ± 0.20	0.50 ± 0.30	0.50+0.20-0.10	0.60 ± 0.15
2512-P	01P	6.50 ± 0.30	3.20 ± 0.20	0.60 ± 0.30	1.50 ± 0.30	0.60 ± 0.10

ELECTRICAL SPECIFICATIONS for CHIP RESISTORS

Size	01005	0201	0402
Power Rating (EIA 575)	0.031 (1/32) W	0.05 (1/20) W	0.063(1/16) W
Working Voltage*	15V	25V	50V
Overload Voltage	30V	50V	100V
Tolerance (%)	±5	±1 ±2 ±5	±1 ±2 ±5
EIA Values	E-24	E-96	E-24
Resistance	10 ~ 1.0M	10 ~ 1M	1.0~9.1Ω, 10~10M
TCR (ppm/°C)	± 250	± 200	± 200
Operating Temp.	-55°C ~ +125°C	-55°C ~ +125°C	-55°C ~ +125°C

Size	0603			0805			1206			1210		
Power Rating (EIA 575)	0.100 (1/10) W			0.125 (1/8) W			0.250 (1/4) W			0.33 (1/3) W		
Working Voltage*	50V			100V			200V			200V		
Overload Voltage	100V			200V			400V			400V		
Tolerance (%)	±1	±2	±5	±1	±2	±5	±1	±2	±5	±1	±2	±5
EIA Values	E-96		E-24	E-96	E-24		E-96	E-24	E-96	E-24		
Resistance	10~1M	1.0 ~ 9.0Ω 1.02M ~ 10M	10Ω ~ 10M	10 ~ 1M	10Ω ~ 10M		10 ~ 1M	10Ω ~ 10M		10 ~ 1M	10Ω ~ 10M	
TCR (ppm/°C)	±100	±200	±200	±100	±200		±100	±200		±100	±200	
Operating Temp.	-55°C ~ +125°C			-55°C ~ +125°C			-55°C ~ +125°C			-55°C ~ +125°C		

Size	2010			2512			2512-P		
Power Rating (EIA 575)	0.500 (1/2) W			1.0 W			2.0 W		
Working Voltage*	200V			200V			200V		
Overload Voltage	400V			400V			400V		
Tolerance (%)	±1	±2	±5	±1	±2	±5	±1	±2	±5
EIA Values	E-96		E-24	E-96	E-24		E-96	E-24	
Resistance	10 ~ 1 M		10Ω ~ 10M	10 ~ 1 M		10Ω ~ 10M	1.0 ~ 1.0M		1.0 ~ 1.0M
TCR (ppm/°C)	±100		±200	±100		±200	±100		±100
Operating Temp.	-55°C ~ +125°C			-55°C ~ +125°C			-55°C ~ +155°C		

* Rated Voltage: $\sqrt{P \times R}$

ELECTRICAL SPECIFICATIONS for ZERO OHM JUMPERS

Series	CJ20 (0201)	CJ05 (0402)	CJ06 (0603)	CJ10 (0805)	CJ18 (1206)	CJ14 (1210)	CJ12 (2010)	CJ01 (2512)
Rated Current	0.5A (70°C)	1A (70°C)	1A (70°C)	2A (70°C)	2A (70°C)	2A (70°C)	2A (70°C)	2A (70°C)
Resistance (Max)	50 m Ω	50 m Ω	50 m Ω	50 m Ω	50 m Ω	50 m Ω	50 m Ω	50 m Ω
Max. Overload Current	1A	2.5A	2.5A	5A	5A	5A	5A	5A
Working Temp.	-55°C ~ +125°C	-55°C ~ +125°C	-55°C ~ +125°C	-55°C ~ +125°C	-55°C ~ +125°C	-55°C ~ +125°C	-55°C ~ +125°C	-55°C ~ +125°C

* Rated Voltage: $\sqrt{P \times R}$

DERATING CURVE

For resistors operated at ambient temperature over 70°, power rating shall be derated in accordance with figure 1.

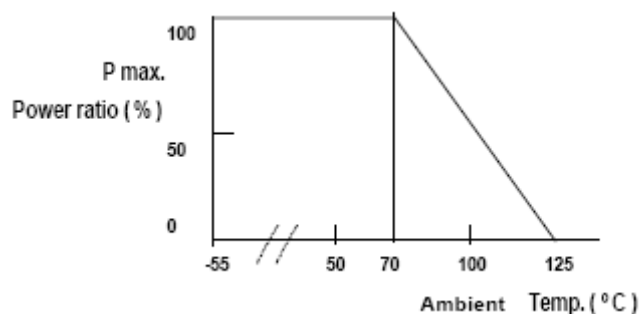

Figure 1

The rated voltage is calculated by the following formula:

$$E = \sqrt{P \times R}$$

E=Rated Voltage(V)

P=Rated Power(W)

R=Resistance Value(Ω)

CHARACTERISTICS

Test Item	Maximum $\Delta \Omega$ +0.05 Ω		Test Conditions
	$\pm 2\%$ & $\pm 5\%$ Tolerance	$\pm 1\%$ & $\pm 0.5\%$ Tolerance	
Short Time Overload	$\pm 0.75\%$	$\pm 0.50\%$	EIA Standard 575, π 3.6 2.5 x rated voltage for 5 seconds
Load Life	$\pm 1.50\%$	$\pm 1.00\%$	EIA Standard 575, π 3.14 90 minutes on; 30 minutes off for 1000 hours
Thermal Shock	$\pm 0.25\%$	$\pm 0.50\%$	EIA Standard 575, π 3.5 -55°C ~ +150°C for 5 cycles
High Temperature Exposure	$\pm 0.50\%$	$\pm 1.25\%$	EIA Standard 575, π 3.7 125°C \pm 5°C continuous for 100 hours
Terminal Strength	$\pm 0.50\%$	$\pm 0.50\%$	EIA Standard 575, π 3.9 20gms @ 90° angle for 30 seconds
Moisture Resistance	$\pm 1.00\%$	$\pm 0.50\%$	EIA Standard 575, π 3.10
Solderability	95% minimum coverage	95% minimum coverage	EIA Standard 575, π 3.12 3 seconds of immersion @ +215°C

EIA Standard Values

Decade Values in the EIA Standard E-24 Series:

1.0	1.1	1.2	1.3	1.5	1.6
1.8	2.0	2.2	2.4	2.7	3.0
3.3	3.6	3.9	4.3	4.7	5.1
5.6	6.2	6.8	7.5	8.2	9.1

Decade Values in the EIA Standard E-96 Series:

1.00	1.02	1.05	1.07	1.10	1.13
1.15	1.18	1.21	1.24	1.27	1.30
1.33	1.37	1.40	1.43	1.47	1.50
1.54	1.58	1.62	1.65	1.69	1.74
1.78	1.82	1.87	1.91	1.96	2.00
2.05	2.10	2.15	2.21	2.26	2.32
2.37	2.43	2.49	2.55	2.61	2.67
2.74	2.80	2.87	2.94	3.01	3.09
3.16	3.24	3.32	3.40	3.48	3.57
3.65	3.74	3.83	3.92	4.02	4.12
4.22	4.32	4.42	4.53	4.64	4.75
4.87	4.99	5.11	5.23	5.36	5.49
5.62	5.76	5.90	6.04	6.19	6.34
6.49	6.65	6.81	6.98	7.15	7.32
7.50	7.68	7.87	8.06	8.25	8.45
8.66	8.87	9.09	9.31	9.53	9.76

Those items in a shaded box are also E-24 values and will be marked with the EIA 3 Digit Code.

VALUE MARKING

For those parts ordered with an E-24 value, the product will be marked with a 3 digit code. For those products ordered with an E-96 value, the product will be marked with a 4 digit code. For those parts which fall under E-96 and E-24 values (e.g. 1K ohm is both an E-96 and E-24 value), the part will be marked with a 3 digit code; 4 digit markings for this type is available upon special request.



01005, 0201, and 0402 Size
No marking
E-24 & E-96 Values



0603 Size
EIA 96 Digit Code of 3.32K ohm
E-96 Values



0603, 0805, 1206, 1210, 2010, 2512 Sizes
EIA 3 Digit Code of 10K ohm resistor
E-24 Values, E-96 Values



0805, 1206, 1210, 2010, 2512 Sizes
EIA 4 Digit Code of 121K ohm resistor
E-96 Values

0603 MARKING CODE for E96 VALUES

By combining a specific two digit number and a letter code, you have a series of numeric/alpha digits that give you the complete (E96) resistance value codes for 0603 size part marking.

Value	Code	Value	Code	Value	Code	Value	Code
10.0	01	17.8	25	31.6	49	56.2	73
10.2	02	18.2	26	32.4	50	57.6	74
10.5	03	18.7	27	33.2	51	59.0	75
10.7	04	19.1	28	34.0	52	60.4	76
11.0	05	19.6	29	34.8	53	61.9	77
11.3	06	20.0	30	35.7	54	63.4	78
11.5	07	20.5	31	36.5	55	64.9	79
11.8	08	21.0	32	37.4	56	66.5	80
12.1	09	21.5	33	38.3	57	68.1	81
12.4	10	22.1	34	39.2	58	69.8	82
12.7	11	22.6	35	40.2	59	71.5	83
13.0	12	23.3	36	41.2	60	73.2	84
13.3	13	23.7	37	42.2	61	75.0	85
13.7	14	24.3	38	43.2	62	76.8	86
14.0	15	24.9	39	44.2	63	78.7	87
14.3	16	25.5	40	45.3	64	80.6	88
14.7	17	26.1	41	46.4	65	82.5	89
15.0	18	26.7	42	47.5	66	84.5	90
15.4	19	27.4	43	48.7	67	86.6	91
15.8	20	28.0	44	49.9	68	88.7	92
16.2	21	28.7	45	51.1	69	90.9	93
16.5	22	29.4	46	52.3	70	93.1	94
16.9	23	30.1	47	53.6	71	95.3	95
17.4	24	30.9	48	54.9	72	97.6	96

Letter Multiplier Cross Reference

A = 10 C = 1,000 E = 100,000 X = 1
B = 100 D = 10,000 F = 1,000,000 Y = 0.1

0603 Code	Explanation	Value
01B	01 = 10.0 & B = 100	10.0x100 = 1K Ω
25C	25 = 17.8 & C = 1,000	17.8x1,000 = 17.8K Ω
93D	93 = 90.9 & D = 10,000	90.9 x 10,000 = 909K Ω

PACKAGE QUANTITY

Type	01005	0201	0402	0603	0805
B				25,000	10,000
M	15,000	10,000	10,000	5,000	5,000
V		40,000	40,000	20,000	20,000

Type	1206	1210	2010	2512
B	5,000			
M	5,000	5,000	4,000	4,000
V	20,000	20,000	20,000	20,000

TAPE SCHEMATIC

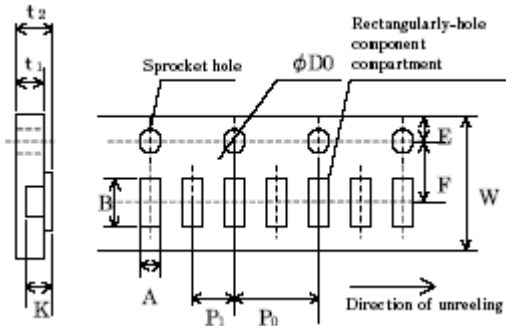

01005 Size

A	B	W	F	E
0.38±0.02	0.68±0.02	8.0±0.10	3.5±0.05	1.75±0.05

P1	P0	D0	t1	t2	K
2.0±0.05	4.0±0.10	1.55±0.03	0.42±0.05	0.5	0.27±0.02

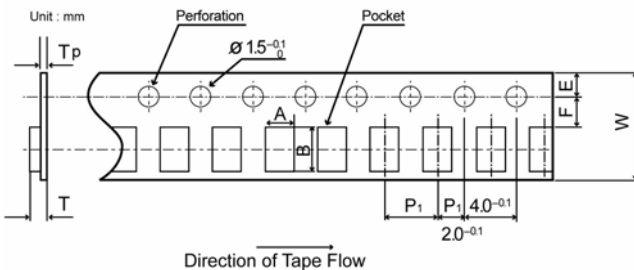

0201 ~ 2512 Size

TAPE DIMENSIONS (mm)

	0201	0402	0603	0805
A	0.41±0.1	0.65±0.1	1.1±0.2	1.65±0.2
B	0.71±0.1	1.15±0.1	1.9±0.2	2.4±0.2
W	8.0±0.2	8.0±0.2	8.0±0.2	8.0±0.2
E	1.75±0.10	1.75±0.10	1.75±0.1	1.75±0.1
F	3.5±0.05	3.5±0.05	3.5±0.05	3.5±0.05
P ₁	2.0±0.05	2.0±0.05	4.0±0.1	4.0±0.1
T	0.5 _{max}	0.55±0.1	0.70±0.1	0.90±0.1
T _p	0.4±0.05	0.40±0.05	0.60±0.1	0.75±0.1

	1206	1210	2010	2512
A	2.0±0.15	2.9±0.1	2.9±0.1	3.4±0.1
B	3.6±0.15	3.5±0.1	5.3±0.1	6.6±0.1
W	8.0±0.2	8.0±0.2	12.0±0.2	12.0±0.2
E	1.75±0.1	1.75±0.1	1.75±0.1	1.75±0.1
F	3.5±0.05	3.5±0.05	5.5±0.05	5.5±0.05
P ₁	4.0±0.1	4.0±0.1	4.0±0.1	4.0±0.1
T	0.90±0.1	0.90±0.1	1.0±0.1	1.0±0.1
T _p	0.75±0.1	0.75±0.1	0.25±0.1	0.25±0.1

TAPE

Type	Resistor Size
Press Pocket Carrier Tape	01005
Rect. Punching Carrier Paper Tape	0201, 0402, 0603, 0805, 1206, 1210
Plastic (Embossed Tape)	2010 & 2512

REEL DRAWINGS

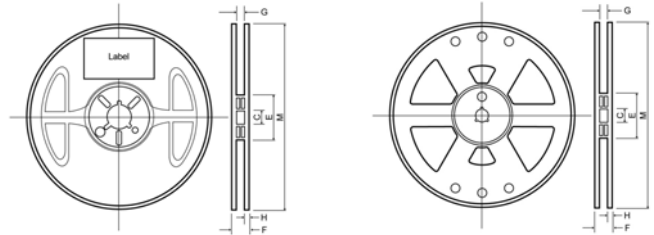

7" Reel (M)

13" Reel (V)

PACKAGE DIMENSIONS (mm)

	7" Reel (M)	13" Reel (V)
M	180 ± 3.0	330±2.5
H	1.20	2.3± 0.5
C	13.0 ± 0.2	13.0 ± 0.2
G	9.0 ± 0.3	9.5 ± 0.5
E	60 ± 1.0	80.0 ± 1.0
F	11.4 ± 1.0	14.4

BULK CASE SCHEMATIC

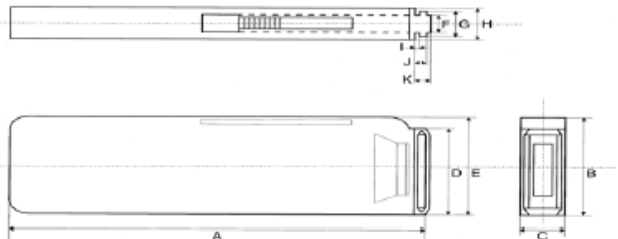

BULK CASE DIMENSIONS (mm)

A	B	C	D	E
110.0±0.7	36.0 ± 0.2	12.0 ± 0.1	31.5±0.2	36.0 ± 0.2

F	G	H	I	J	K
6.8 ± 0.1	8.8 ± 0.1	12.0 ± 0.1	1.5 ± 0.1	2.0± 0.1	4.7± 0.1

LABEL DESCRIPTION

One side surface of a reel is marked with a label with the following items of information.

1. Chip Resistor
2. Part Number
3. Tolerance
4. Quantity
5. Lot number for production month/year/suffix L*
6. Manufacturer's name or symbol

* The suffix "L" indicates that this item is lead free. As of September 2004, all new production items of the series CR and CJ are no longer containing tin/lead (SnPb) terminals; they are lead free and in compliance with Lead Free/RoHS.



THICK FILM CHIP RESISTORS

The content of this specification may change without notification 10/07/2011



CR-KITS Series, Thick Film Chip Resistor Engineering Kits

This engineering and design kit is a great sales tool, allowing for application testing before ordering minimum quantities. AAC offers a wide assortment of popular chip resistors sizes and tolerances, in addition to a large quantity of each value. The kits are convenient with easy-to-use packaging.

PACKAGE CONSTRUCTION

- 3 Ring Binder Case Holder
- Plastic pages with slip holders for each value
- Each value is individually identified in a slip holder
- Resistors are packaged on paper tape strips

E-24 KIT VALUES

2.2	10	47	180	560	1.8K	5.6K	18K	56K	270K
2.7	18	68	220	680	2.2K	6.8K	22K	82K	390K
3.9	22	75	270	850	2.7K	8.2K	27K	100K	470K
4.7	27	100	330	1.0K	3.3K	10K	33K	120K	560K
6.8	33	120	390	1.2K	3.9K	12K	39K	150K	1.0M
8.2	39	150	470	1.5K	4.7K	15K	47K	220K	2.2M

E-96 KIT VALUES

10.0	24.3	56.2	133	301	681	1.62K	4.22K	10.0K	23.7K	60.4K	150K	332K	649K
11.3	26.1	61.9	150	332	750	1.82K	4.75K	11.0K	27.4K	68.1K	162K	365K	681K
12.1	28.7	68.1	162	348	825	2.00K	5.11K	12.1K	30.1K	75.0K	178K	392K	732K
13.3	33.2	75.0	174	383	909	2.21K	5.62K	13.0K	33.2K	82.5K	200K	422K	750K
15.0	35.7	82.5	200	422	1.00K	2.37K	6.19K	15.0K	39.2K	90.9K	221K	464K	825K
16.5	39.2	90.9	215	475	1.10K	2.67K	6.81K	16.2K	41.2K	100K	237K	511K	866K
18.2	42.2	100	237	511	1.21K	3.01K	7.50K	18.2K	47.5K	110K	255K	536K	909K
20.0	46.4	107	261	549	1.33K	3.32K	8.25K	20.0K	49.9K	121K	274K	562K	953K
22.1	51.1	118	287	604	1.50K	3.92K	9.09K	22.1K	56.2K	130K	301K	619K	1.0M

Engineering Kits J Type

FEATURES

- EIA Standard E-24 Values
- Full range from 1 Ω ~ 1M Ω
- Resistance Tolerance of $\pm 5\%$
- 3,000 Pieces: 50 pieces of 60 different values
- ISO 9002 Quality Certified products

Part Number for $\pm 5\%$ Sample Kit

Part Number	Description
CR05-J-KITS	0402, 1/16w, 5%, E-24 values (1 Ω through 2.2M Ω)
CR16-J-KITS	0603, 1/16w, 5%, E-24 values (1 Ω through 2.2M Ω)
CR10-J-KITS	0805, 1/10w, 5%, E-24 values (1 Ω through 2.2M Ω)
CR18-J-KITS	1206, 1/8w, 5%, E-24 values (1 Ω through 2.2M Ω)

Engineering Kits F Type

FEATURES

- EIA Standard E-24 Values
- Full range from 10 Ω ~ 1M Ω
- Resistance Tolerance of $\pm 1\%$
- 3,150 Pieces: 25 pieces of 126 different values
- ISO 9002 Quality Certified products

Part Number for $\pm 1\%$ Sample Kit

Part Number	Description
CR05-F-KITS	0402, 1/16w, 1%, E-96 values (10 Ω through 1M Ω)
CR16-F-KITS	0603, 1/16w, 1%, E-96 values (10 Ω through 1M Ω)
CR10-F-KITS	0805, 1/10w, 1%, E-96 values (10 Ω through 1M Ω)
CR18-F-KITS	1206, 1/8w, 1%, E-96 values (10 Ω through 1M Ω)

